

General Feature

- Absorbent Glass Mat(AGM) technology for efficient gas recombination of up to 99% and freedom from electrolyte maintenance or water adding.
- Not restricted for air transport-complies with IATA/ICAO Special Provision A67.
- UL-recognized component.
- Can be mounted in any orientation.
- Computer designed lead, calcium tin alloy grid for high power density.
- Long service life, float or cyclic applications.
- Maintenance-free operation.
- Low self discharge.

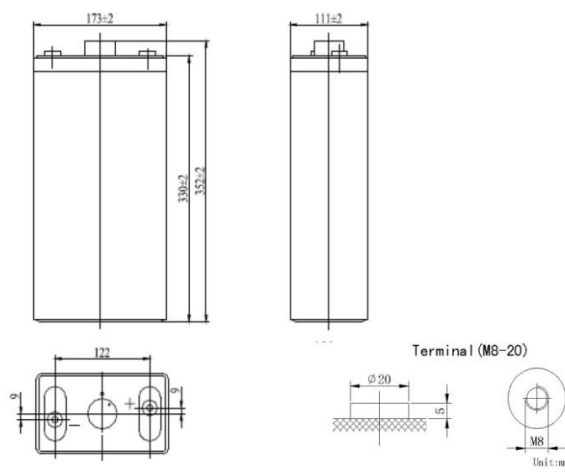

Total height with removable cover:364

SPECIFICATION

Nominal voltage	2V
Number of cell	1
Length(mm/inch)	173/6.81
Width(mm/inch)	111/4.37
Height(mm/inch)	330/13.0
Total Height(mm/inch)	352/13.7
Approx.Weight(kg/lbs)	13.5/29.8

Battery Construction

Component	Positive plate	Negative plate	Container	Cover	Safety valve	Terminal	Separator	Electrolyte
Raw material	Lead dioxide	Lead	ABS	ABS	Rubber	Copper	Fiberglass	Sulfuric acid

Performance Characteristics

Capacity 77°F(25°C)	10 hours rate(20A 1.80V)	200Ah
	5 hours rate(36A 1.75V)	168Ah
	3 hours rate(53A 1.70V)	159Ah
	1 hour rate(125A 1.60V)	125Ah
Internal Resistance	Full charged battery 77°F(25°C):0.75mΩ	
Capacity affected by Temperature (10 hour rate)	104°F(40°C)	102%
	77°F(25°C)	100%
	32°F(10°C)	85%
	5°F(-15°C)	65%
Self-Discharge 68°F(20°C)	Capacity after 3 month storage	90%
	Capacity after 6 month storage	80%
	Capacity after 12 month storage	60%
Max discharge current77°F(25°C):1000A(5S)		
Charge (Constant Voltage)	Float:2.25 to 2.30V/77°F/(25°C)	
	Cycle:2.35 to 2.45V/77°F/(25°C) Max Current:40A	

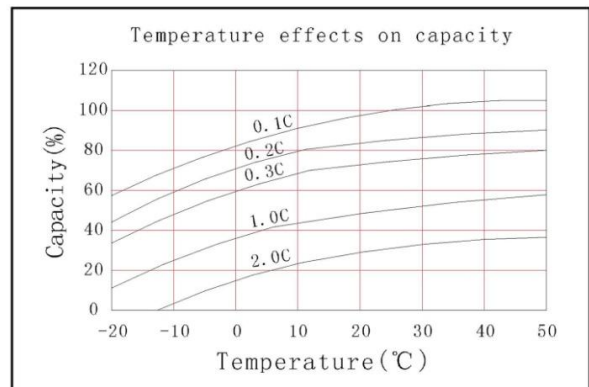
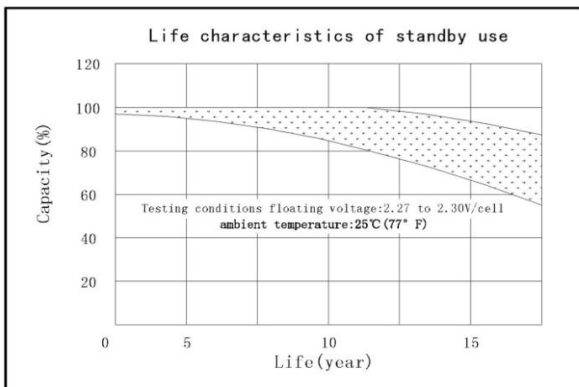
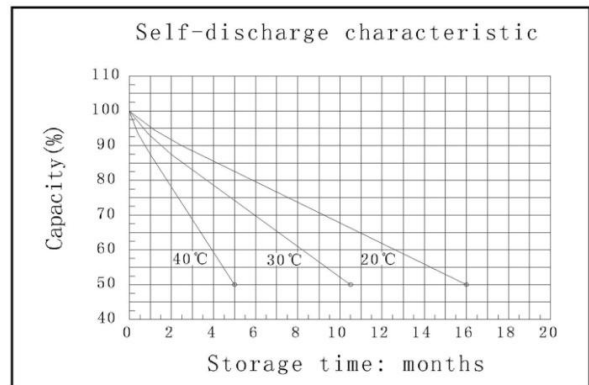
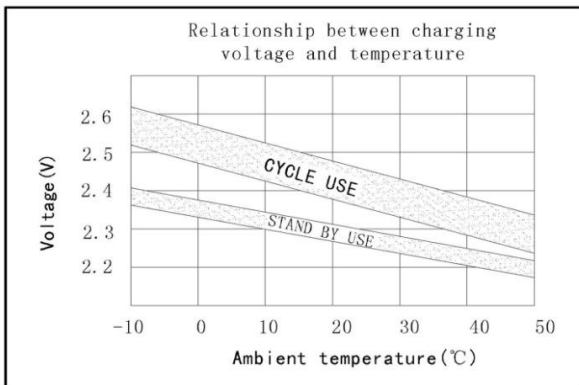
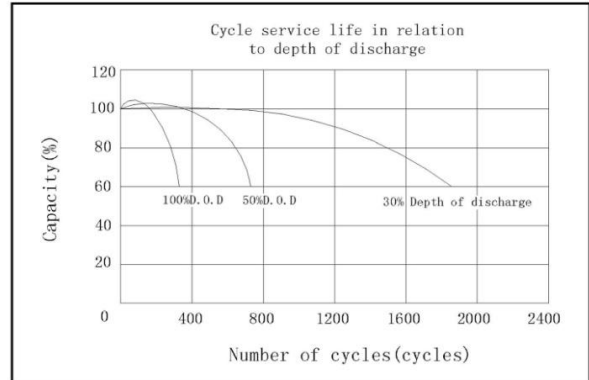
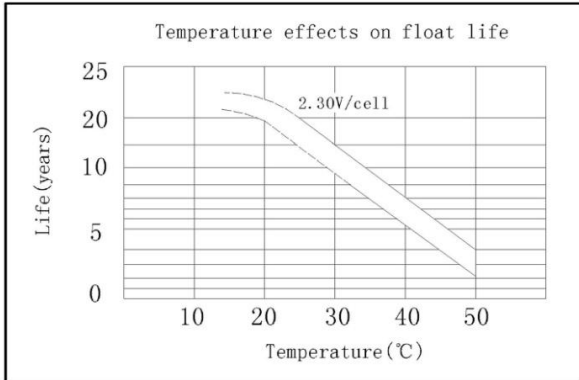
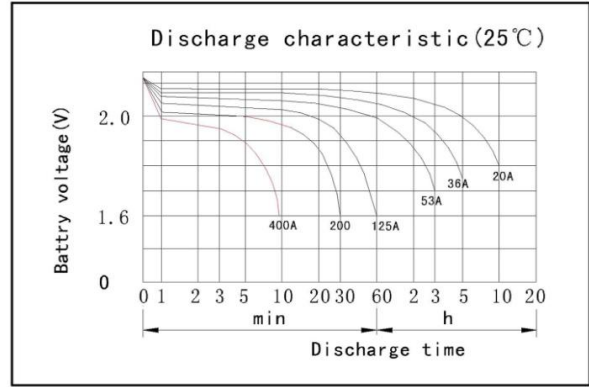
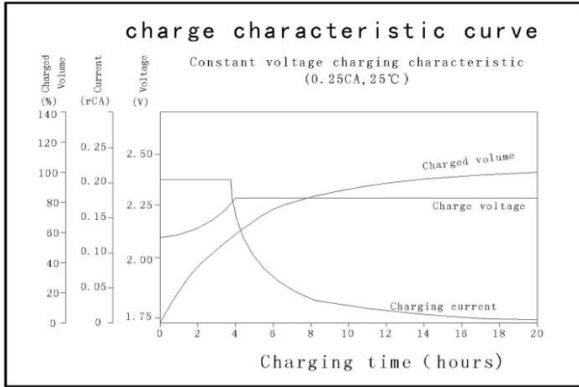

Discharge Constant Current (Amperes at 77° F 25 °C)

End Point Volts/Cell	5min	10min	15min	30min	45min	1h	3h	5h	10h
1.60V		390	294	200	162	125	56.6	38.8	21.4
1.65V		370	280	192	155	121	54.8	38.0	21.2
1.70V		348	265	183	148	116	53.0	37.1	20.9
1.75V		327	250	172	141	111	50.0	36.0	20.5
1.80V		305	235	160	134	105	48.6	35.0	20.0

(Note)The above characteristics data are average values obtained Within three charge/discharge cycles not the minimum values.

Discharge Constant Power (watts at 77° F 25 °C)

End Point Volts/Cell	5min	10min	15min	30min	45min	1h	2h	3h	5h
1.60V		580	524	380	308	245	146	106	78.0
1.65V		559	499	364	299	235	142	104	76.6
1.70V		538	473	348	289	224	137	101	75.1
1.75V		517	446	331	280	213	132	98.0	73.5
1.80V		495	420	315	272	201	126	94.7	71.7

(Note)The above characteristics data are average values obtained Within three charge/discharge cycles not the minimum values.